

Description and application

Grilles intake and exhaust have one row of movable blades embedded in the front frame in horizontally configuration. For use in installation low and medium pressure. Adjusting the angle is manual and the individual for each blade.

Grille has Hygienic Certificate HK/K/0522/01/2016

Material and workmanship

The grille is all made of galvanized steel sheet powder coated white RAL 9016. On request it is possible to paint in a different color from the RAL palette and made on special stainless steel or aluminum.

Size

Grilles are manufactured to order. Grilles dimension by the customer request.

L - width of the mounting hole

H - height of the mounting hole

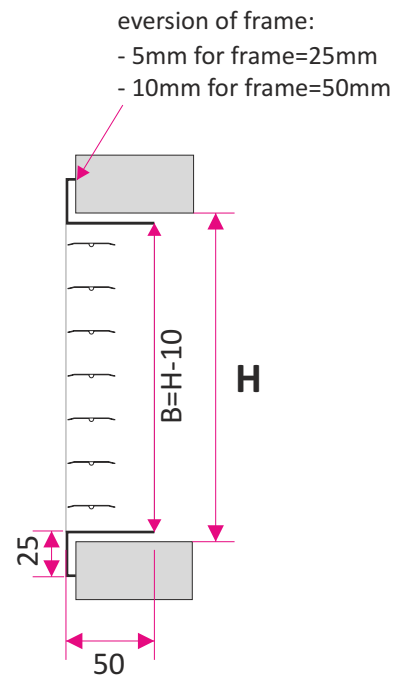
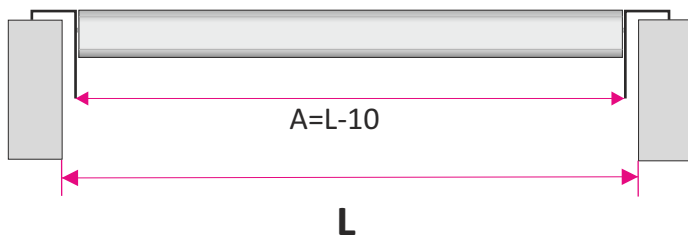
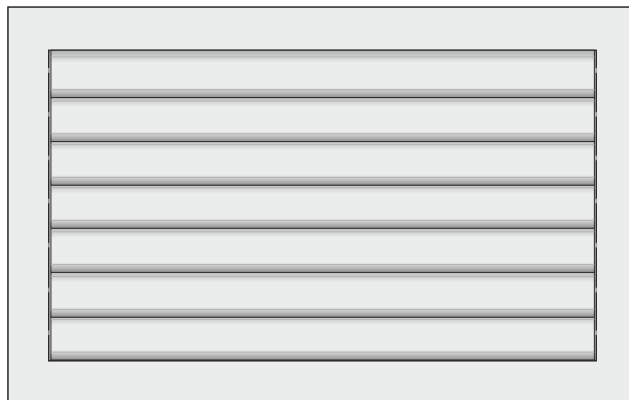

For $L > 600$ the grille is divided (extra stiffened)

width of the frame:

25mm for L or $H \leq 1000$ mm

50mm for L or $H > 1000$ mm

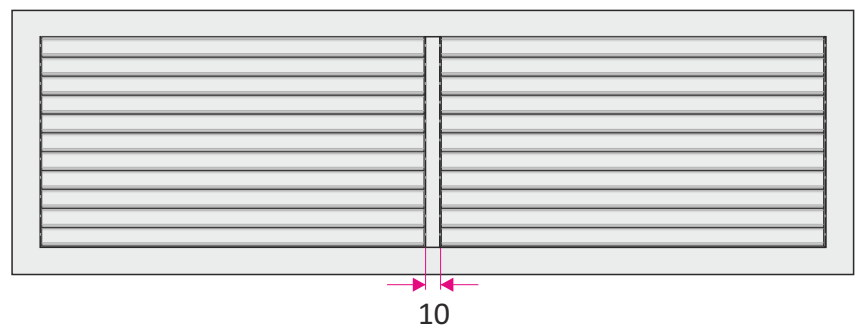

Methods of mounting

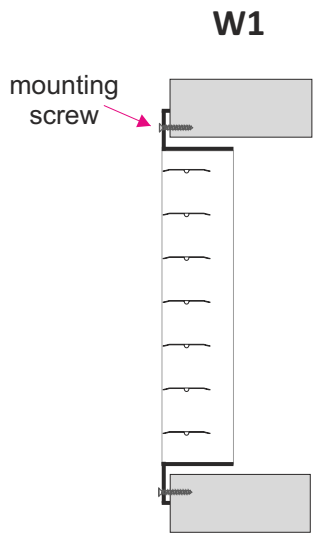

Assembling visible through screws and mounting holes in the grille frame.

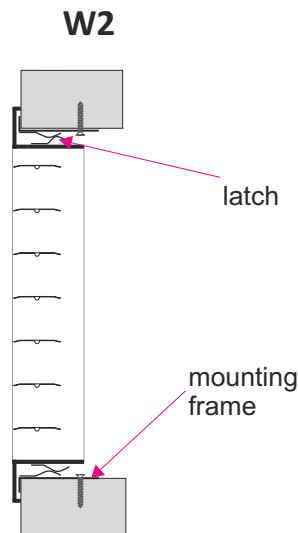

Assembling invisible by latches in grille and mounting frame RM or in plenum box.

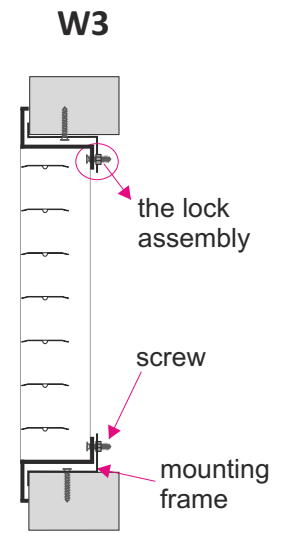

Assembling invisible by screws and lock assembly in mounting frame RM or in plenum box (recommended for invisible installation in the ceiling).

Accessories - RM frame for invisible installation

RM frame used in the ventilation holes for invisible mounting ventilation components. Mounting frame for grilles in standard are made of galvanized steel (in the case of aluminum grilles on request frame can be also aluminum). There is possibility to make mounting frame with a filter.

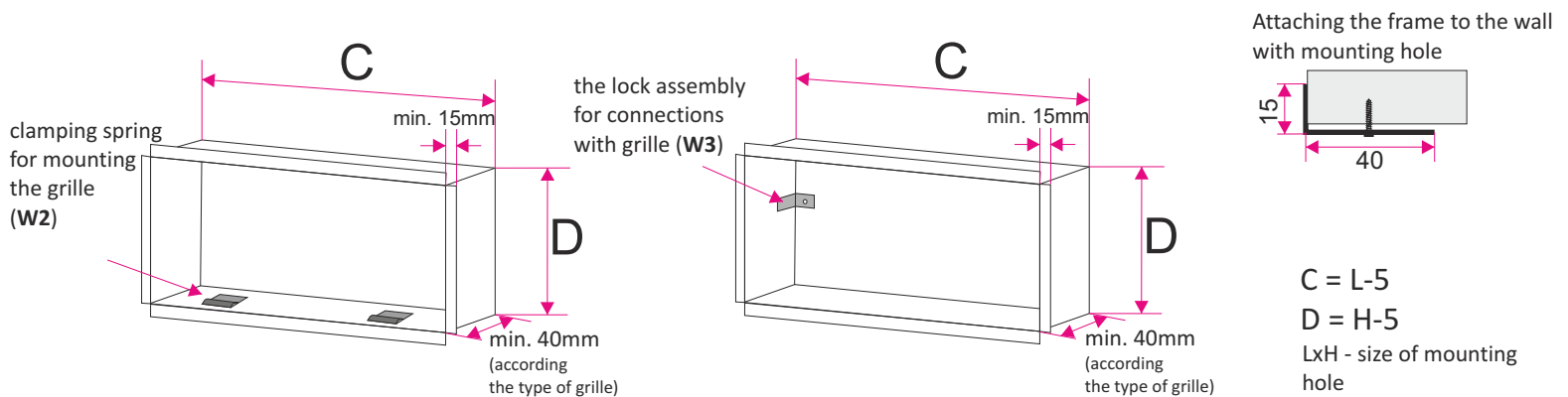

Accessories- plenum box

Plenum box is made of galvanized steel. On request it can be equipped with a damper control onto the connected spigot. The plenum box is isolated inside with rubber (acoustic) or outside with mineral wool (thermal). In the standard height of the plenum box is adapted to size of the spigot or diffuser size (you can specify the height of the plenum box).

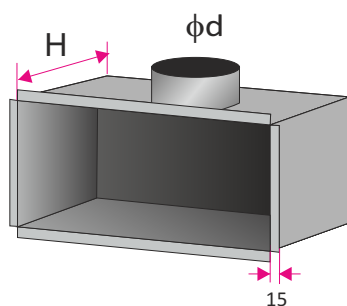

SR-Gw - plenum box with the spigot on the top

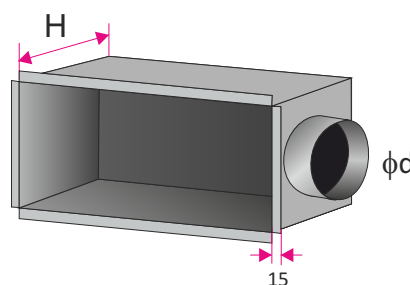

SR-Bw - plenum box with the spigot on the side

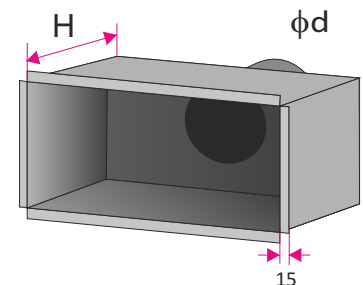

SR-Tw - plenum box with the spigot on the back

TECHNICAL DATA

The dependence of pressure drop ($\Delta p_{..}$), maximum speed of air stream (V_{ef}), acoustic power level (L_{WA}) and the range air stream of speed $V=0,25$ m/s ($L_{0,25}$) of air volume flow (Q) with grilles at open dampers. Velocity V_{ef} means maximum speed of air outflow measured at the outlet the grille. Range $L_{0,25}$ refers to the distance at which the air speed does not exceed 0,25 m/s.

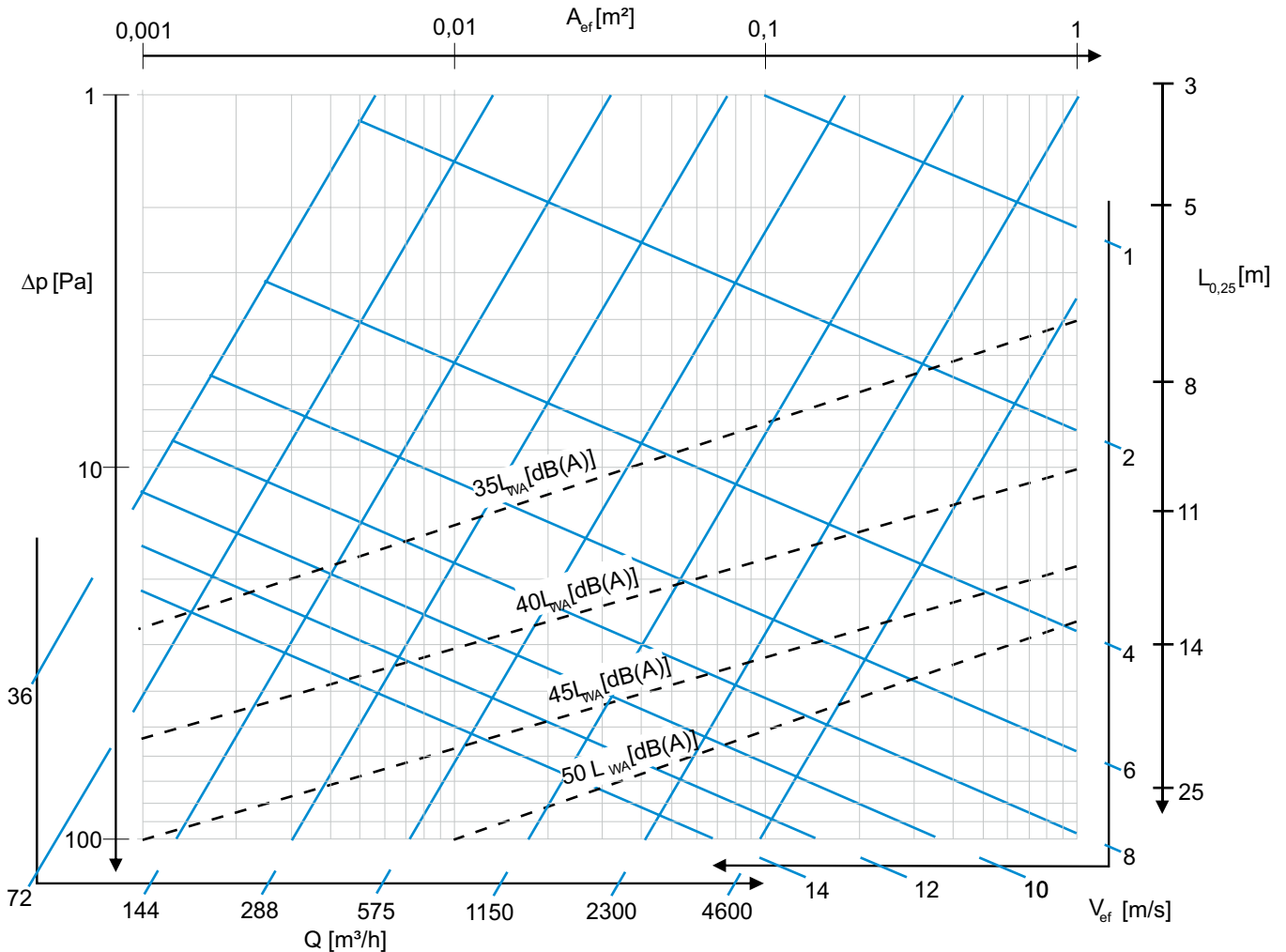
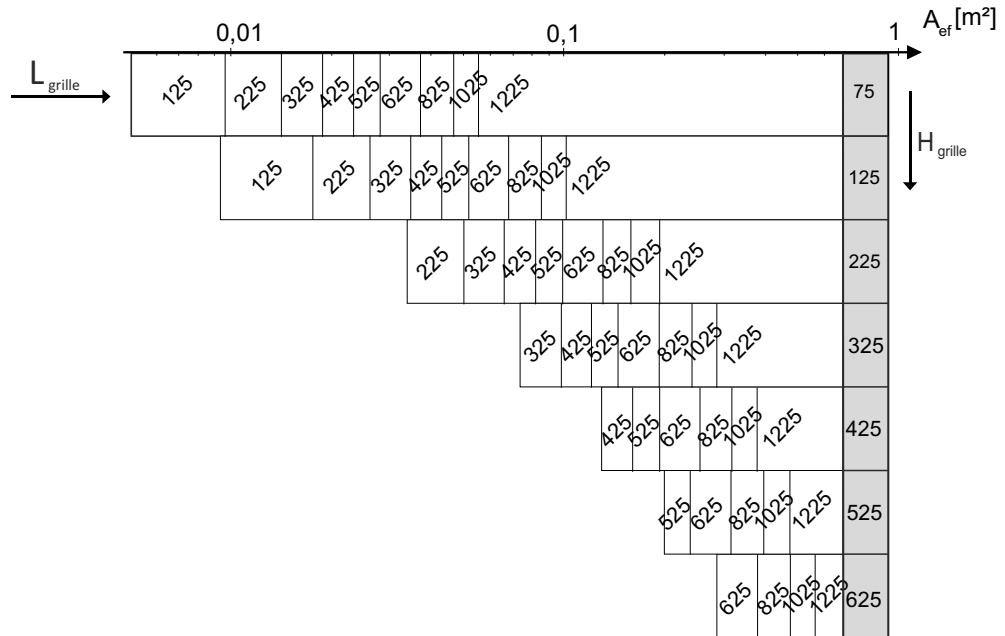

H \ L	125	225	325	425	525	625	825	1025	1225
75									
125									
225									
325									
425									
525									
625									

 normal size

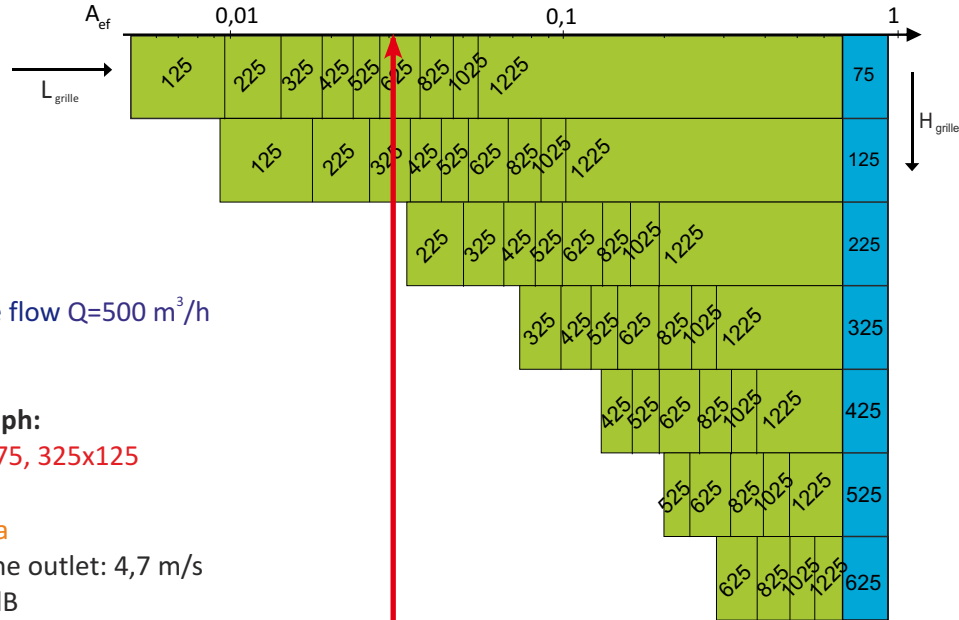

EXAMPLE

- specified air volume flow $Q=500 \text{ m}^3/\text{h}$
- range $L_{0,25}=10 \text{ m}$

Reading from the graph:

- suitable grille: 625x75, 325x125
- $A_{ef} = 0,03 \text{ m}^2$
- pressure drop: 10 Pa
- effective speed at the outlet: 4,7 m/s
- acoustic power 35 dB

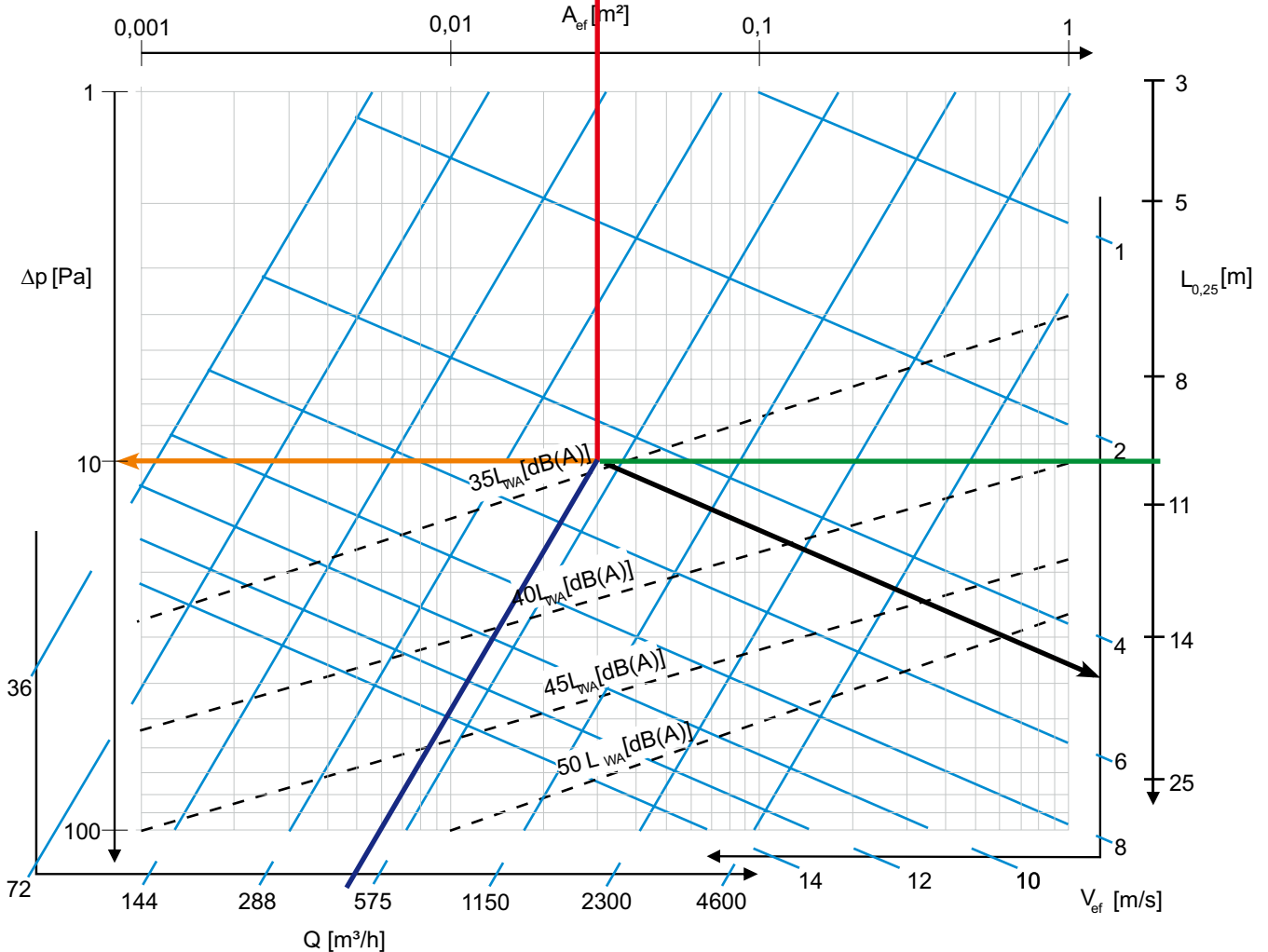

The method of placing an order

Please make orders according to the following formula:

ST-W/ 'LxH' / 'RAL' / 'W' / 'M' + 'SR' / 'I' / 'P' / 'K' / 'H₁'

'LxH'	- mounting hole size (width x height) in mm
'RAL'	- grille color according to RAL palette (standard RAL9016*)
'W'	- material: OC - powder coated steel* AL - aluminum powder coated KO - stainless steel / acid proof steel (type 1.4301 or 1.4404)
'M'	- mounting option: W1 - visible assembly through screws in holes in grille front frame W2 - invisible mounting using latch springs and additional mounting frame W3 - invisible assembly using screws, and an additional mounting frame
'SR'	- plenum box: SR-Gw - plenum box with top spigot connection SR-Bw - plenum box with side spigot connection SR-Tw - plenum box with back spigot connection
'I'	- isolation: none - plenum box without isolation* Iz - outside isolation (thermal) Iw - inside isolation (acoustic)
'P'	- adjustment damper at spigot connection: none - no damper* P - damper on spigot connection adjustable from the outside PP - damper on spigot connection adjustable from the inside
'K'	- diameter spigot connection in size mm
'H ₁ '	- the height of the plenum box in mm*

* - If you don't give the information will be used standard parameters.