

## Description and application

Round swirl diffusers NWO-11, with the function of changing the direction of the ventilation, willingly used in the industry (production halls) and wherever to increase the level of comfort mentions a large amount of air. They have also the use in public buildings such as restaurants, conference rooms and hospitals. Diffusers are mounted in conjunction with plenum box or directly on the ventilation ducts in ceilings or directly under the ceiling. Change the direction of the flow of air from horizontal to vertical (pointing down), makes this diffuser especially useful in case the rapid heating-up (several times faster than in the case of horizontal ventilation) or efficient cooling-levels of airflow direction.

Changes in the direction of the airflow is followed by adjusting:

- a) manual (**RR**)
- b) Belimo acuator control (**RS-E**)
- c) using a wax actuator (**RS-W**)

In the case of a diffuser with a wax actuator, the angle of the diffuser blades automatically changes depending on the supply air temperature. With this solution you don't need additional source of electricity or power.

Thanks to the movable diffuser blades round swirl diffusers NWO-11 can operate in either cooling function and heating.

**Diffusers have the Hygienic Certificate HK/K/0522/01/2016**

## Material and workmanship

Diffusers are made of galvanized sheet steel powder coated, standard on the white color 9016 or on request to any color from the RAL palette. On request can be made of stainless steel or aluminum.

Ceiling diffusers NWO-11 can be equipped with modular plate, for example size 595x595mm adapted for installation in ceiling suspended.

## Size

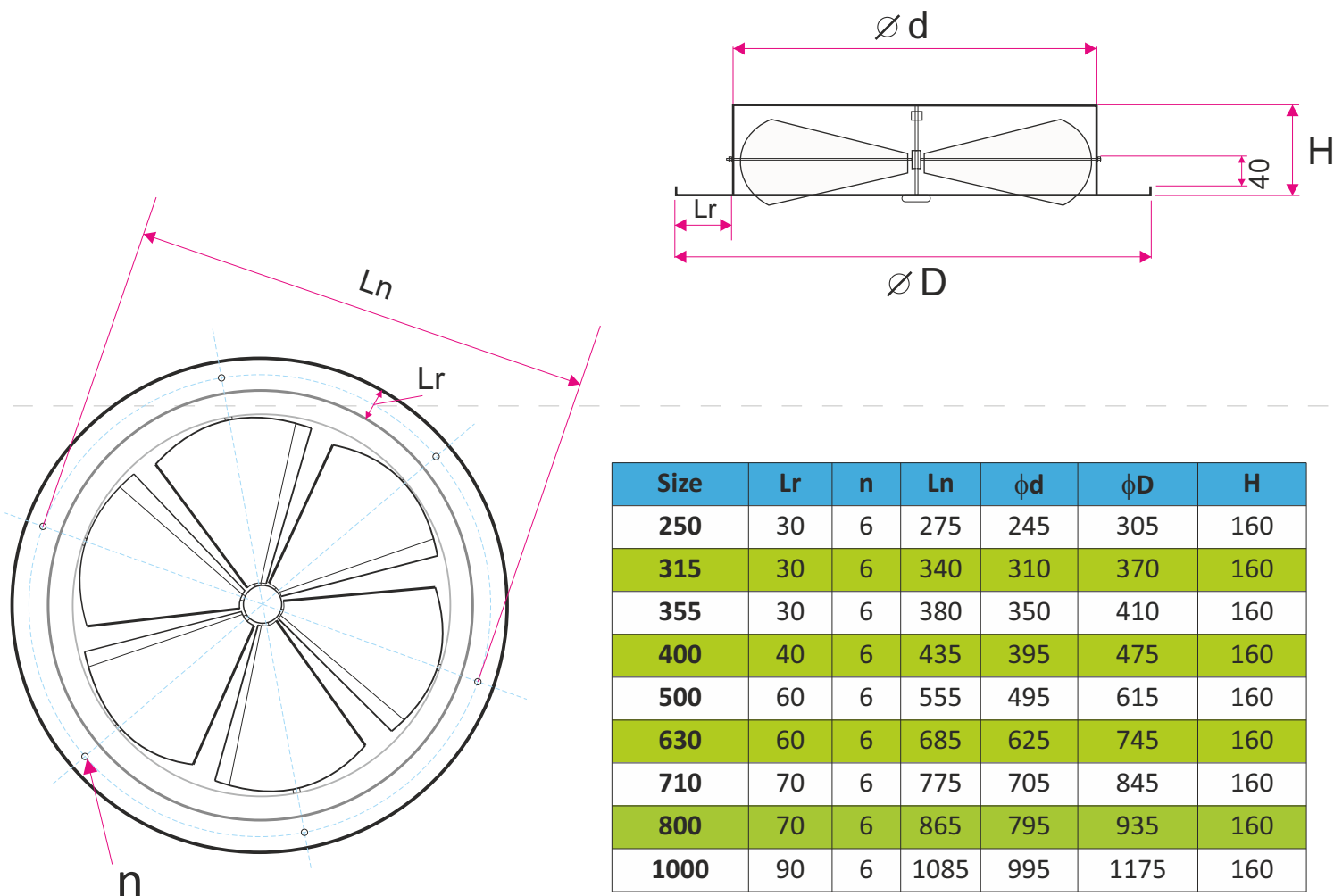

## OPERATING MODE OF DIFFUSER NWO-11

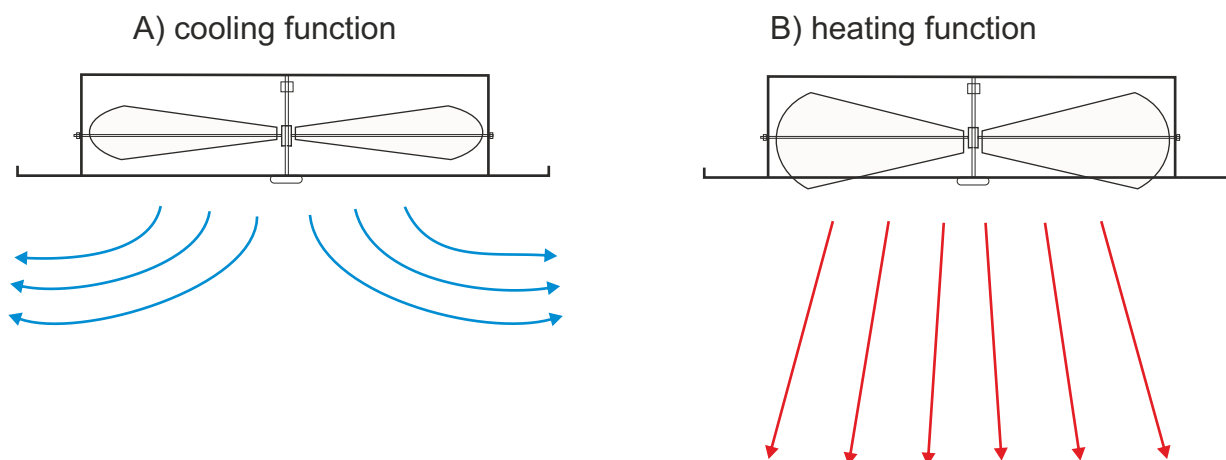

### Accessories: plenum box

Plenum box is made of galvanized steel. On request it can be equipped with a damper control onto the connected spigot. The box can be isolated inside with rubber (acoustic) or outside with mineral wool (thermal). In the standard height of the plenum box is adapted to size of the spigot or diffuser size (you can specify the height of the plenum box).

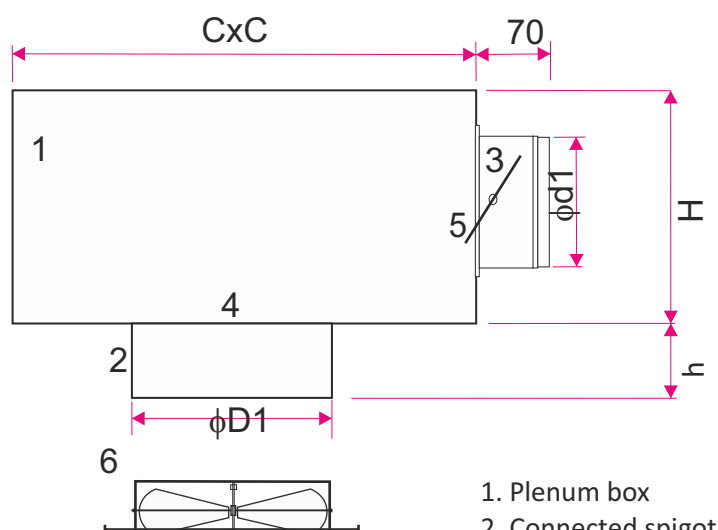

1. Plenum box
2. Connected spigot
3. Air intake spigot
4. Crossbar
5. Adjustment damper
6. Round swirl diffuser NWO-11

| Size | C    | H   | $\phi d1$ | $\phi D1$ |
|------|------|-----|-----------|-----------|
| 250  | 400  | 280 | 198       | 250       |
| 315  | 580  | 330 | 248       | 315       |
| 355  | 580  | 330 | 248       | 355       |
| 400  | 590  | 380 | 313       | 400       |
| 500  | 700  | 380 | 313       | 500       |
| 630  | 800  | 595 | 398       | 630       |
| 710  | 900  | 595 | 398       | 710       |
| 800  | 1000 | 595 | 398       | 800       |
| 1000 | 1250 | 595 | 398       | 1000      |

Depending on the method for adjusting diffuser spigot height (h) may be two quantities:

- for manual control (RR) - h= 145mm
- for regulating with actuator(RS) -h= 200mm

**Methods of mounting**

Swirl round diffusers NWO-11 can be fitted directly on a circular duct using self-drilling screws (variant W1), or using screws at the back of the diffuser mounted in the channel / box crosspiece (variant W2).

The diffuser can also be screwed to the ceiling through the mounting holes in the diffuser frame (variant of W3).

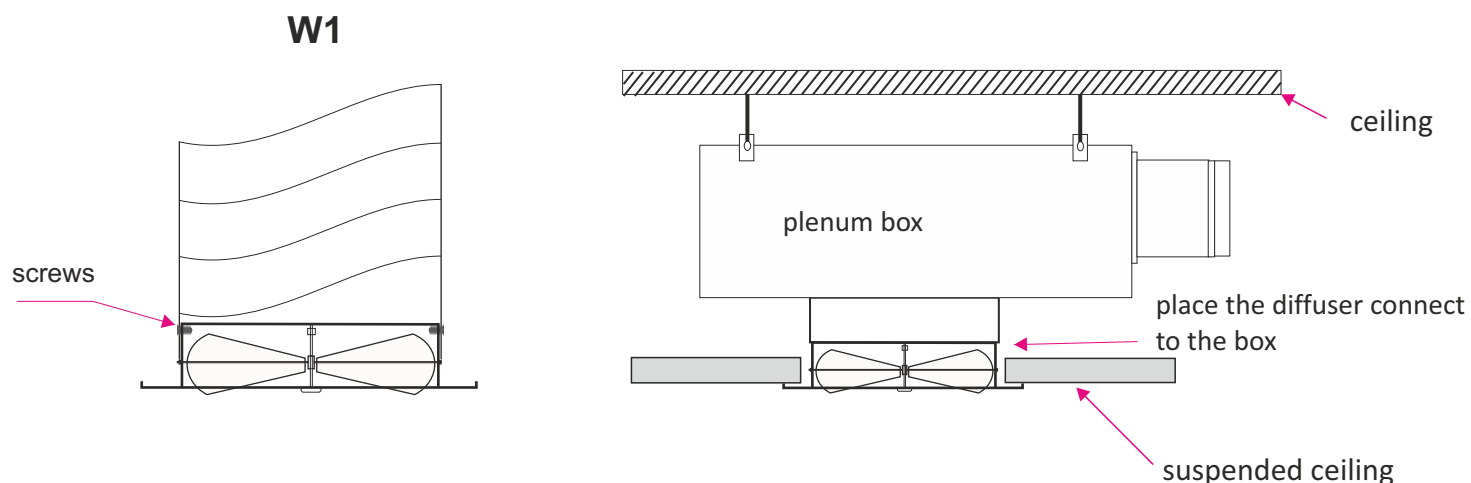

Mounting screws directly into the duct round or spigot connection plenum box.

**ATTENTION**

For dimensions of 710, 800, ... mounted in the ceiling, is used exclusively variant assembly W3 (mounting holes in the frame)

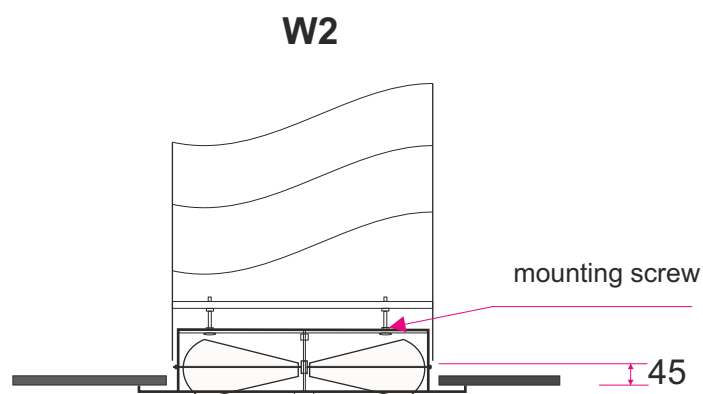

Screw mounting placed inside the diffuser to a fastening strip round duct or spigot connection plenum box . Fixing is possible at max. the opening of the blades the diffuser.

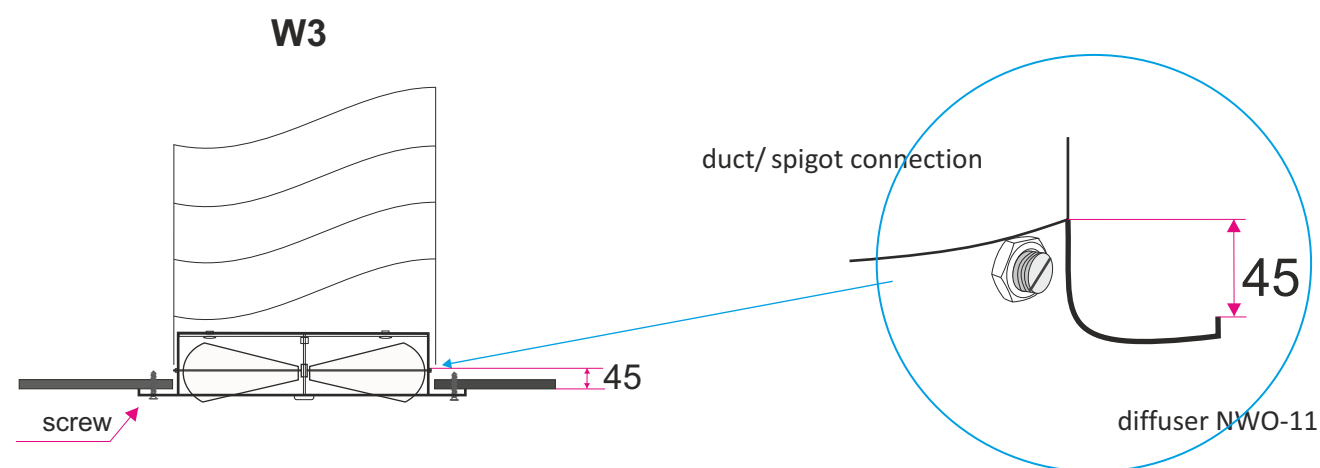

Screw mounting directly to the plate

## Technical data

The angle of the blades depending on the height of the room, temperature and air stream (cooling).

### Round swirl diffuser NWO-11 Dn-250 COOLING

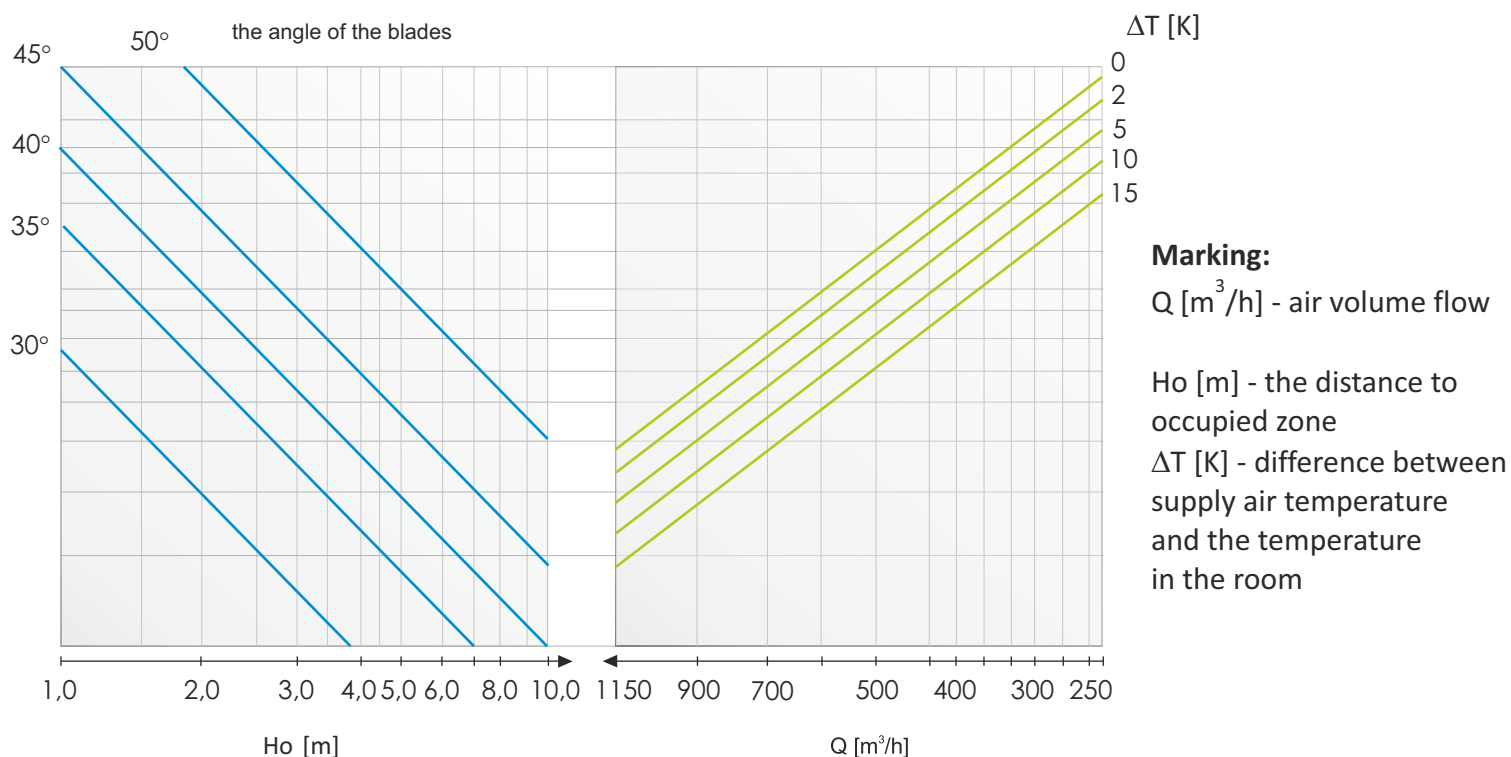

### Round swirl diffuser NWO-11 Dn-315 COOLING

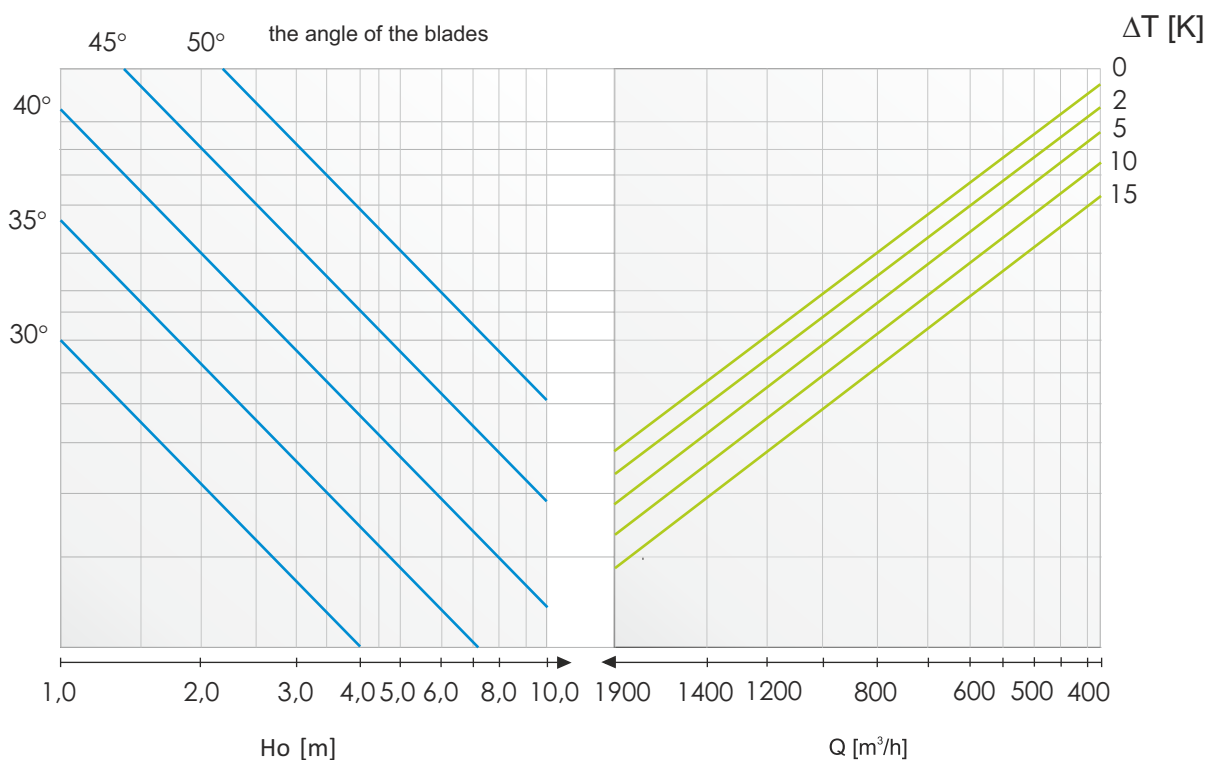

## Technical data

The angle of the blades depending on the height of the room, temperature and air stream (cooling).

### Round swirl diffuser NWO-11 Dn-400 COOLING

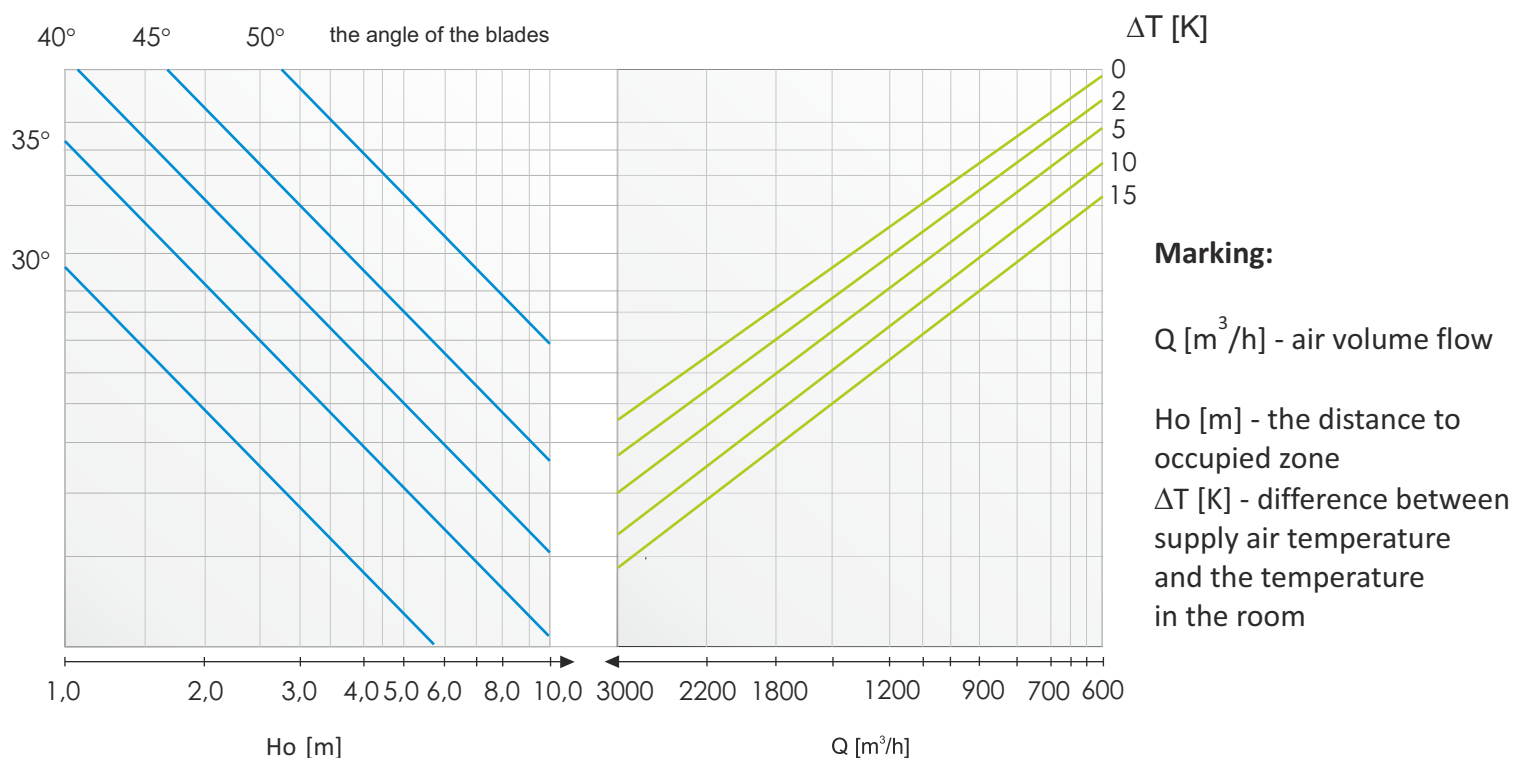

### Round swirl diffuser NWO-11 Dn-500 COOLING

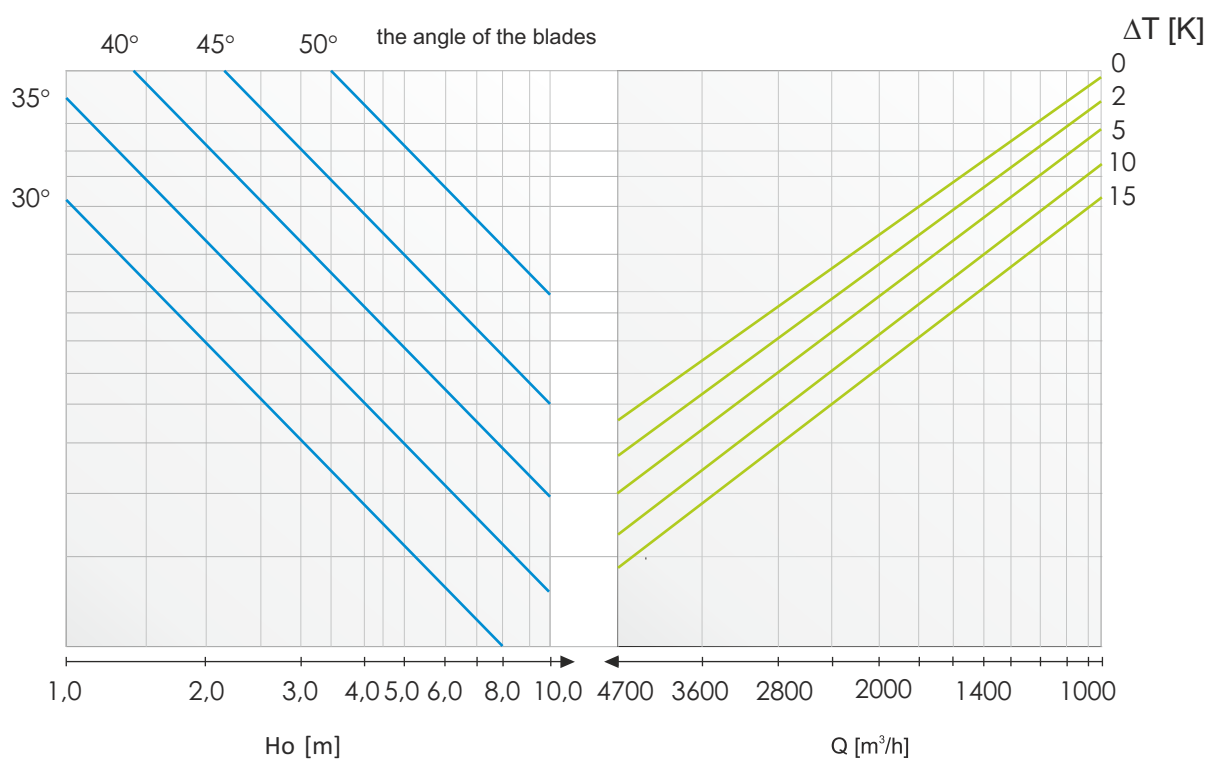

## Technical data

The angle of the blades depending on the height of the room, temperature and air stream (cooling).

### Round swirl diffuser NWO-11 Dn-630 COOLING

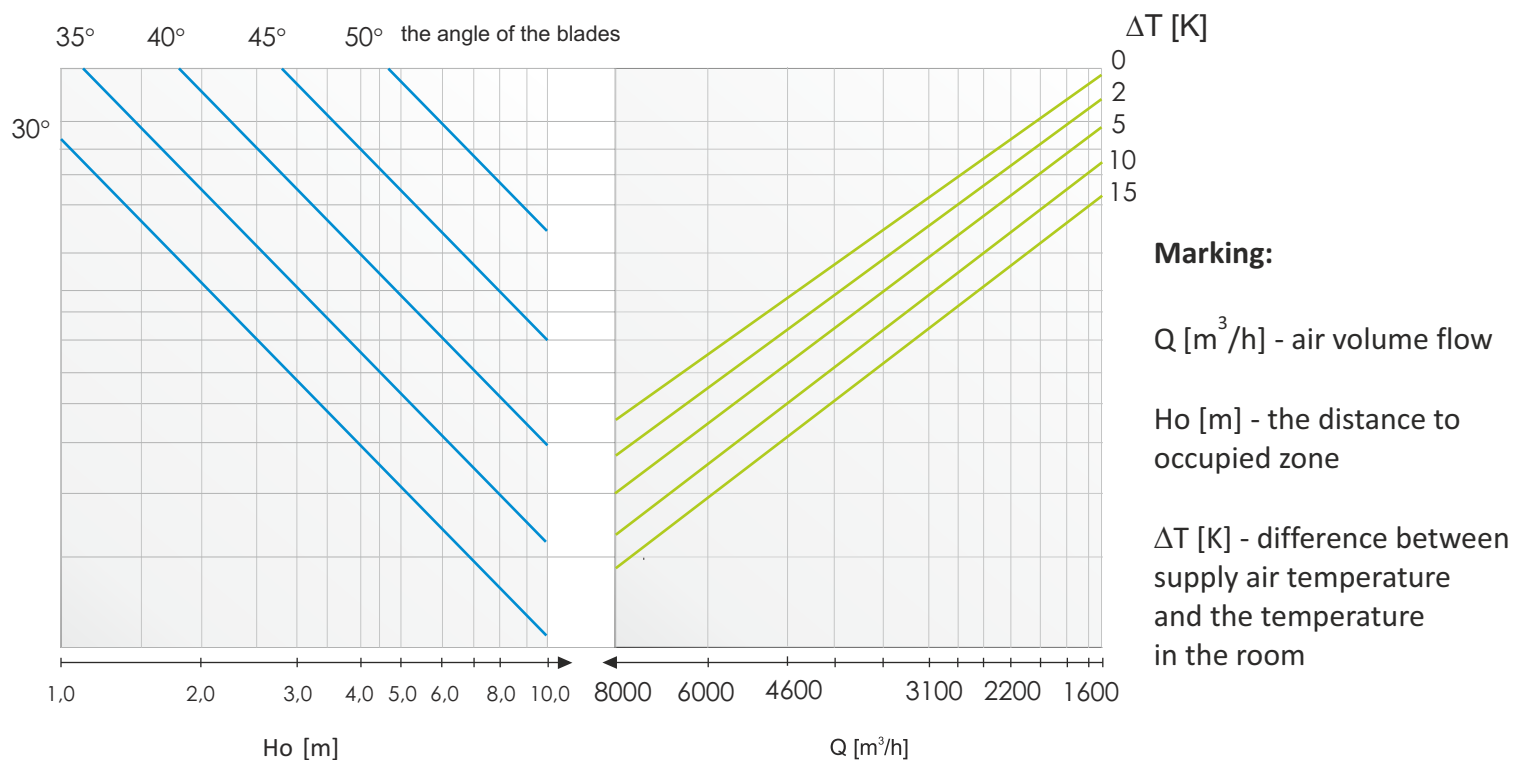

### Round swirl diffuser NWO-11 Dn-710 COOLING

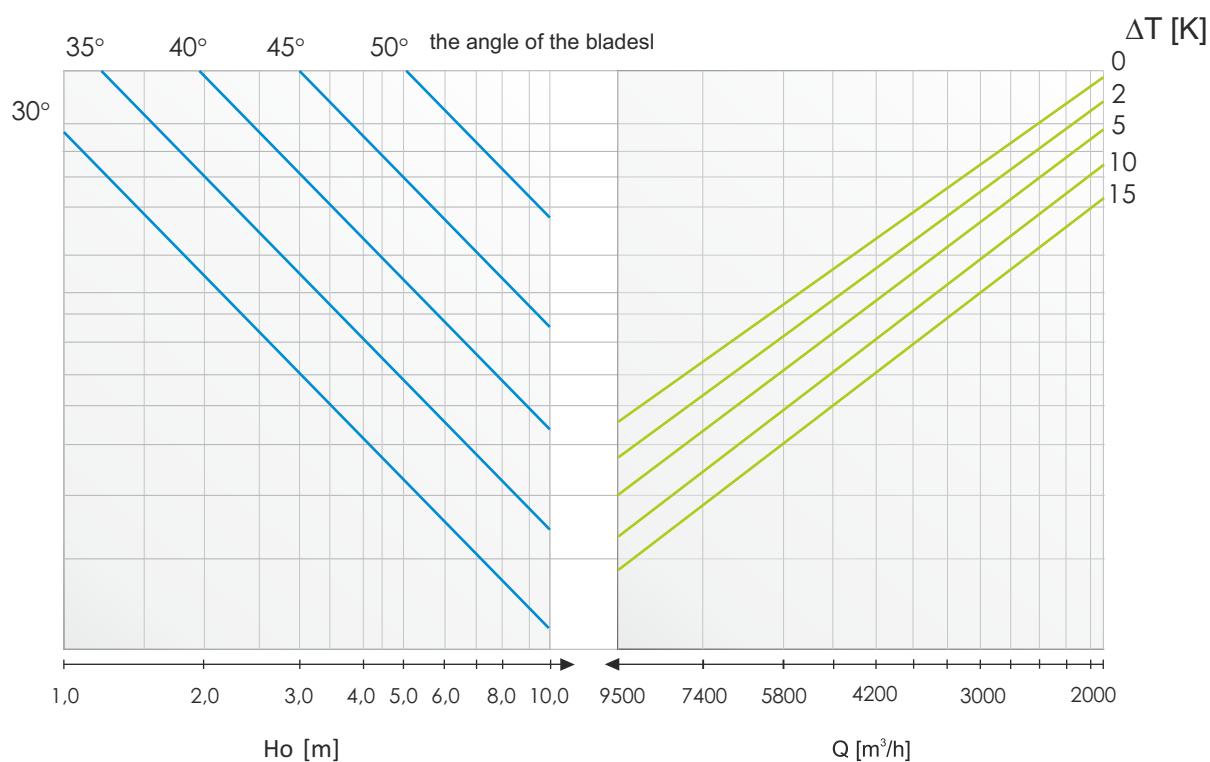

## Technical data

The angle of the blades depending on the height of the room, temperature and air stream (cooling).

### Round swirl diffuser NWO-11 Dn-800 COOLING

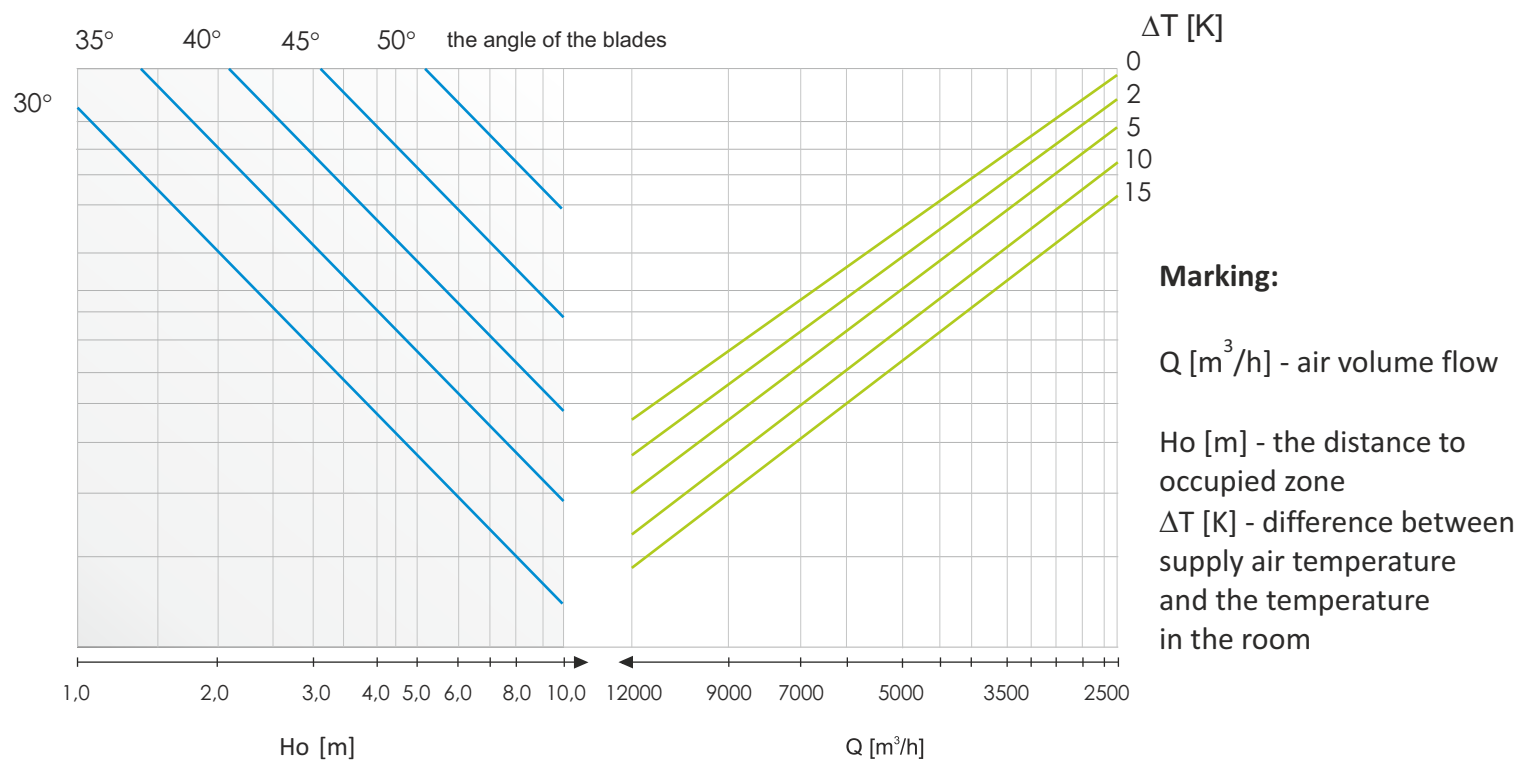

## Technical data

The angle of the blades depending on the height of the room, temperature and air stream (heating).

### Round swirl diffuser NWO-11 Dn-250 HEATING

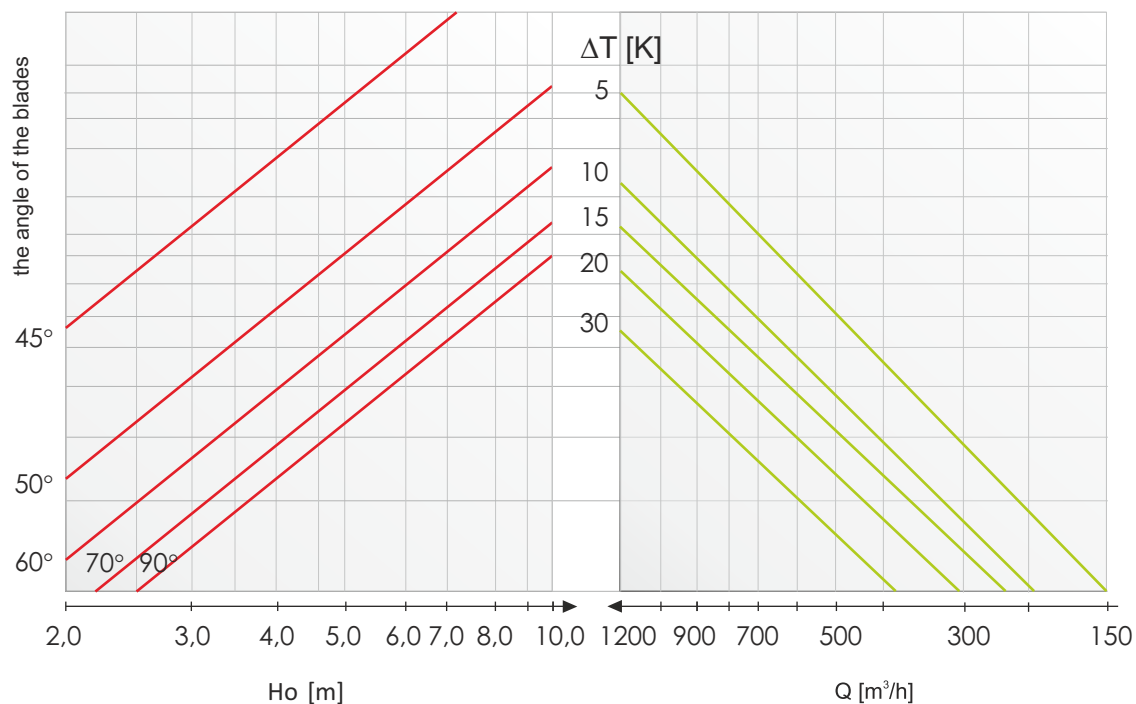

#### Marking:

$Q [m^3/h]$  - air volume flow

$H_o [m]$  - the distance to occupied zone

$\Delta T [K]$  - difference between supply air temperature and the temperature in the room

### Round swirl diffuser NWO-11 Dn-315 HEATING

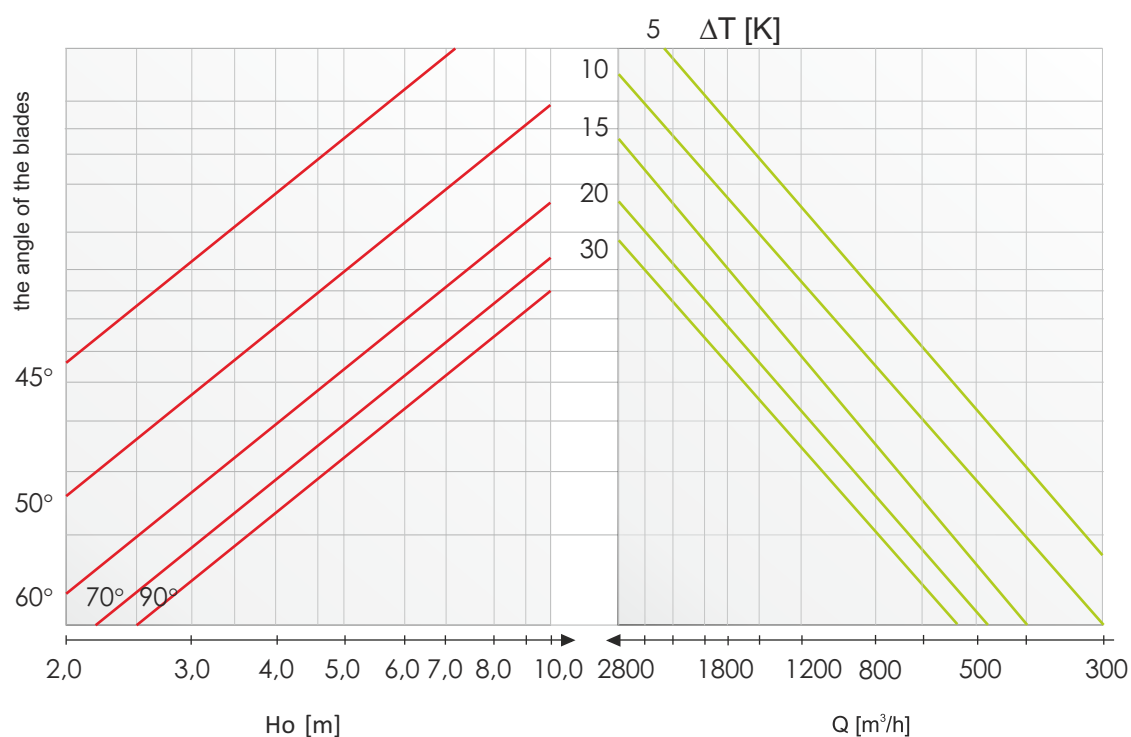



## Technical data

The angle of the blades depending on the height of the room, temperature and air stream (heating).

### Round swirl diffuser NWO-11 Dn-400 HEATING

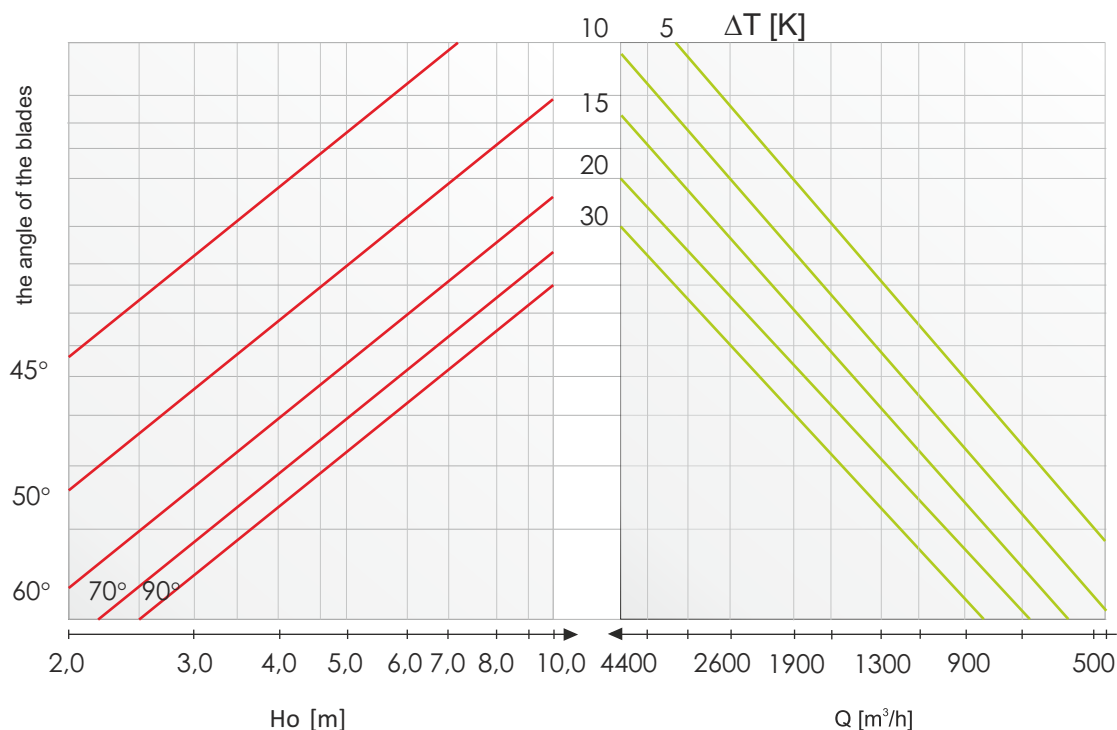

#### Marking:

$Q [m^3/h]$  - air volume flow

$H_o [m]$  - the distance to occupied zone

$\Delta T [K]$  - difference between supply air temperature and the temperature in the room

### Round swirl diffuser NWO-11 Dn-500 HEATING

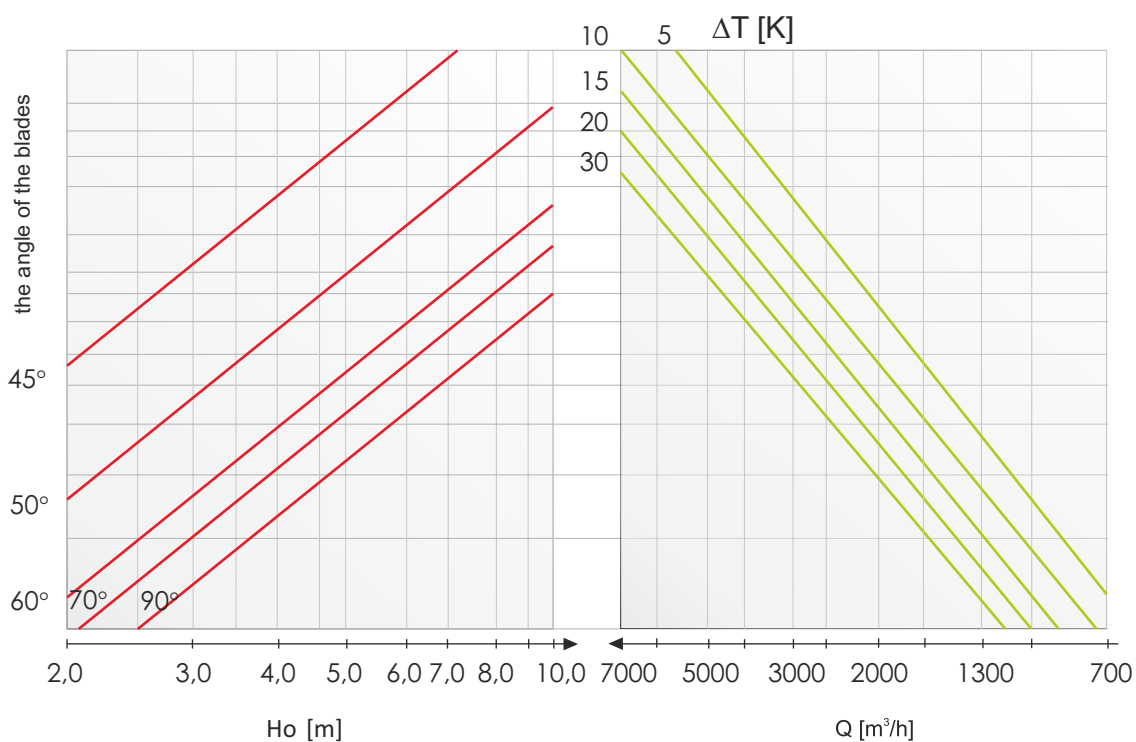

## Technical data

The angle of the blades depending on the height of the room, temperature and air stream (heating).

### Round swirl diffuser NWO-11 Dn-630 HEATING

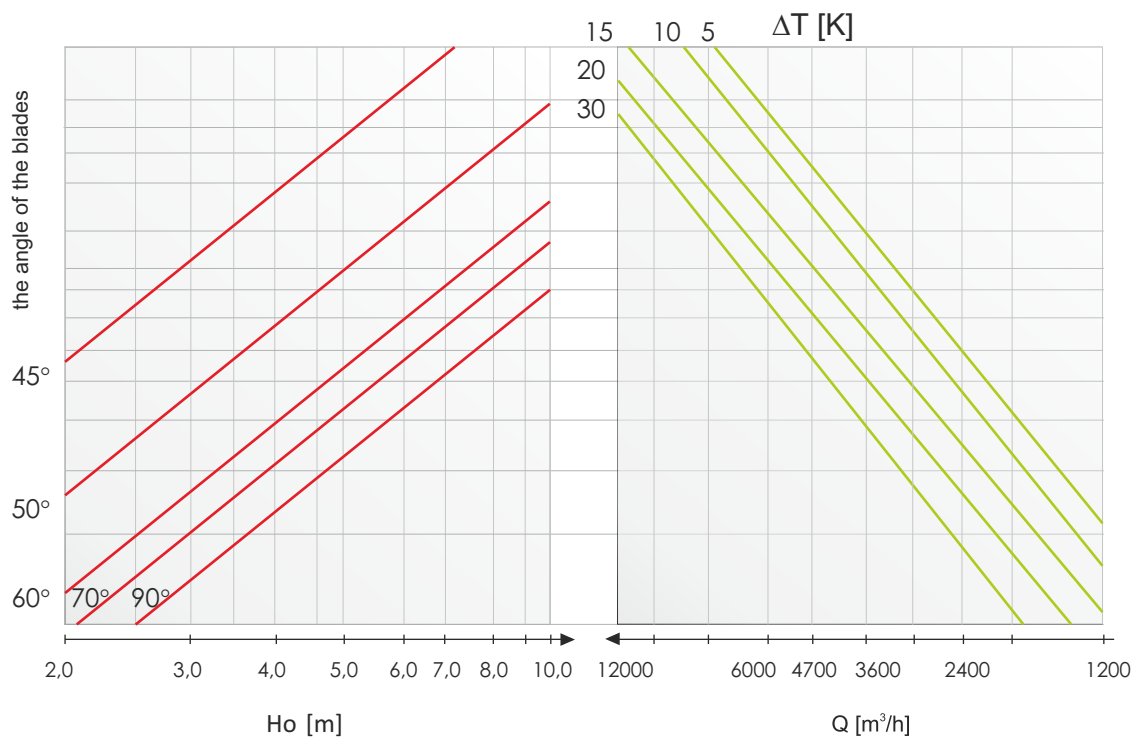

**Marking:**

Q [m<sup>3</sup>/h] - air volume flow

Ho [m] - the distance to occupied zone

ΔT [K] - difference between supply air temperature and the temperature in the room

### Round swirl diffuser NWO-11 Dn-710 HEATING

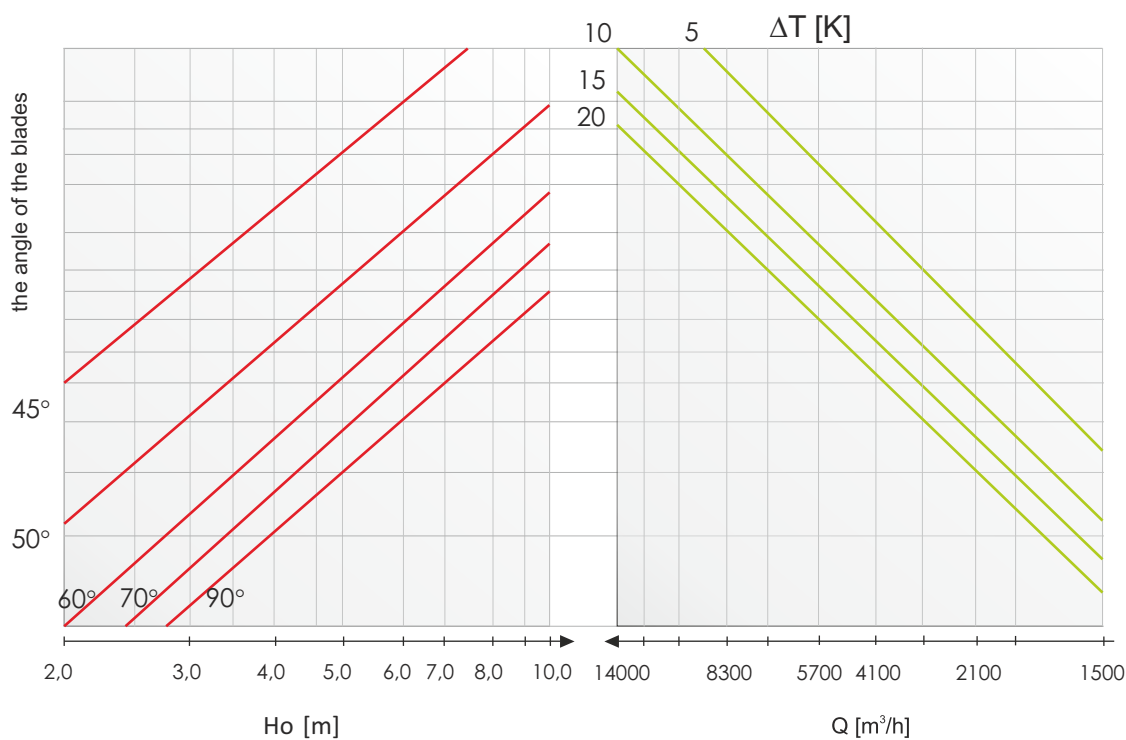

## Technical data

The angle of the blades depending on the height of the room, temperature and air stream (heating).

### Round swirl diffuser NWO-11 Dn-800 HEATING

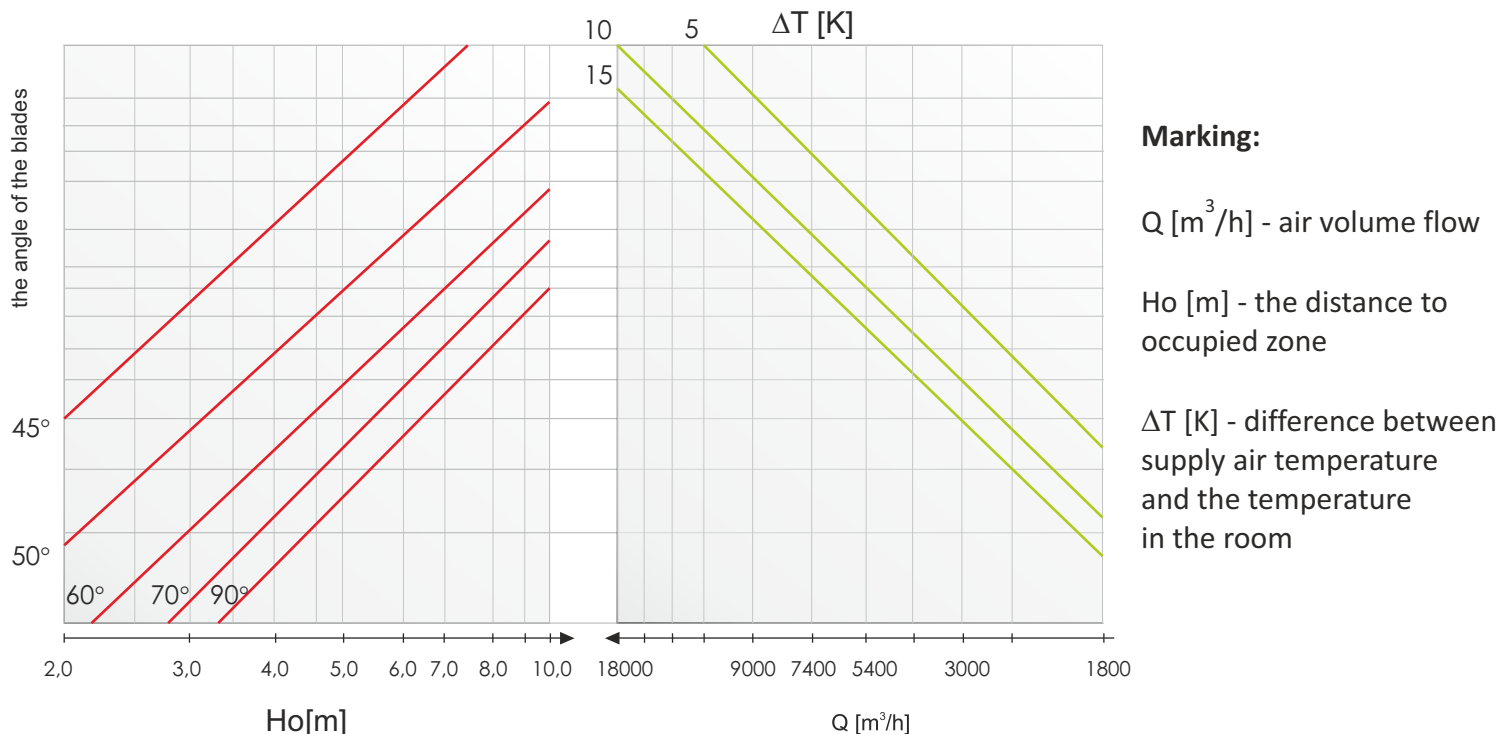

The recommended distance between the diffusers depending on the speed of air flow from the diffuser  $v_{ef}$  (m/s).

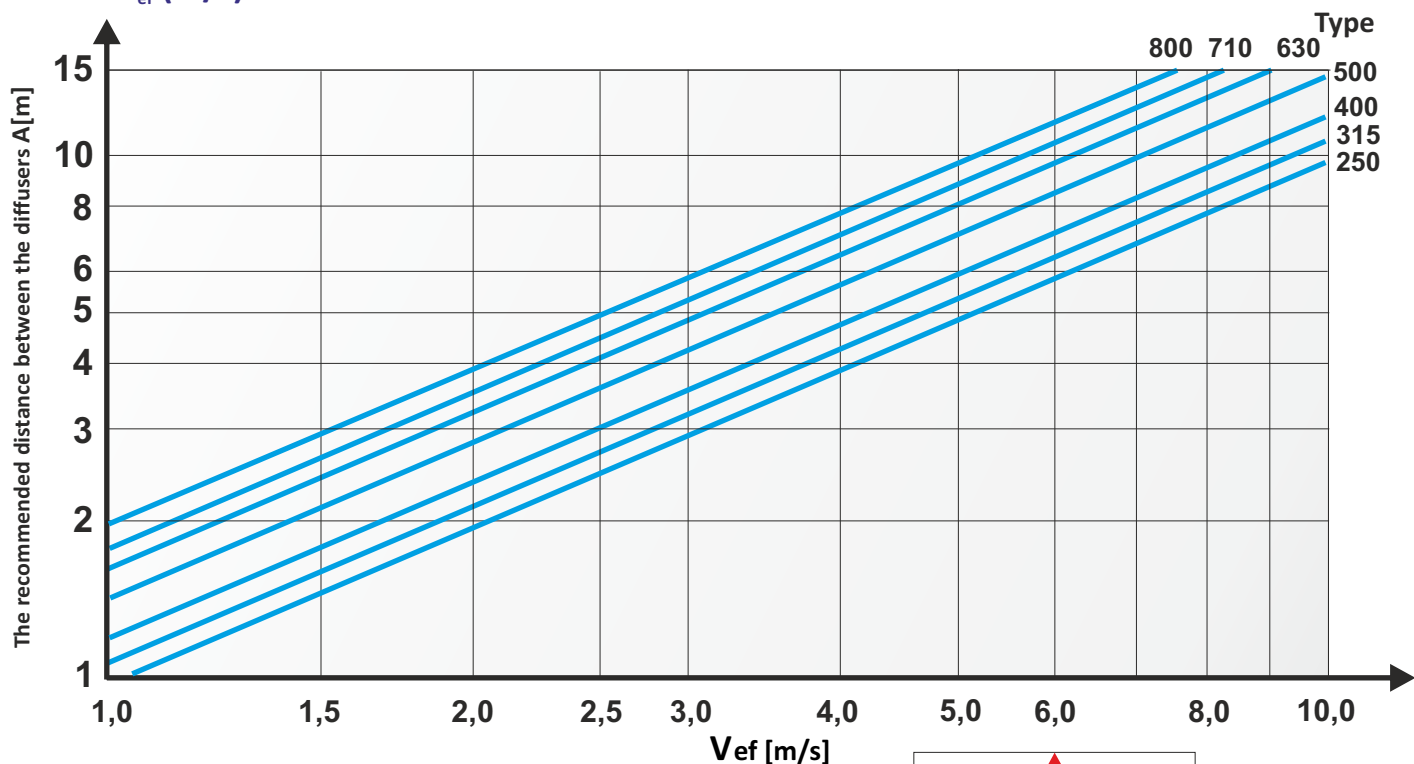

#### Designation:

$A$  [m]- The recommended distance between the diffusers

$v_{ef}$  [m/s]- speed flow of air from the diffuser

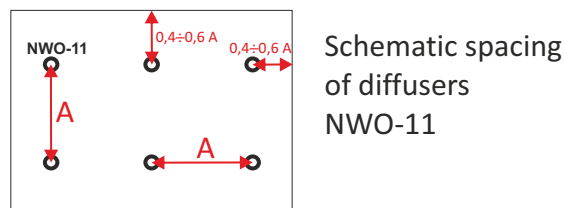

## PRESSURE DROP AND ACOUSTIC POWER

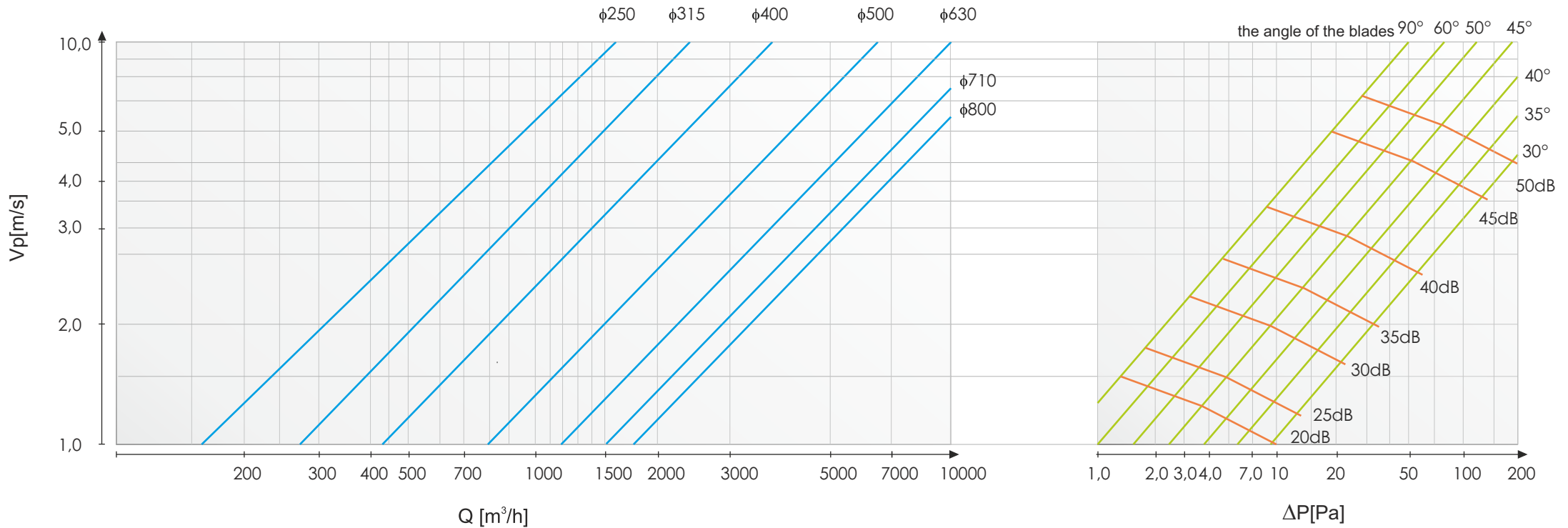

### Designation:

$Q$  [m³/h] - air volume flow

$T$  [K] - difference between supply air temperature and the temperature in the room

$V_p$  [m/s] - the speed of air flowing from the diffuser

$\Delta P$  [Pa] - pressure drop through the diffuser

LWA[dB(A)] - acoustic power

**EXAMPLE**

- round swirl diffuser NWO-11 ( $\phi 630$ )
- air volume flow  $Q=2000 \text{ m}^3/\text{h}$
- the angle of the blades  $35^\circ$

**Reading from the graph:**

- pressure drop through the diffuser  $\Delta p=18 \text{ Pa}$
- acoustic power  $L_{WA} < 35 \text{ dB}$

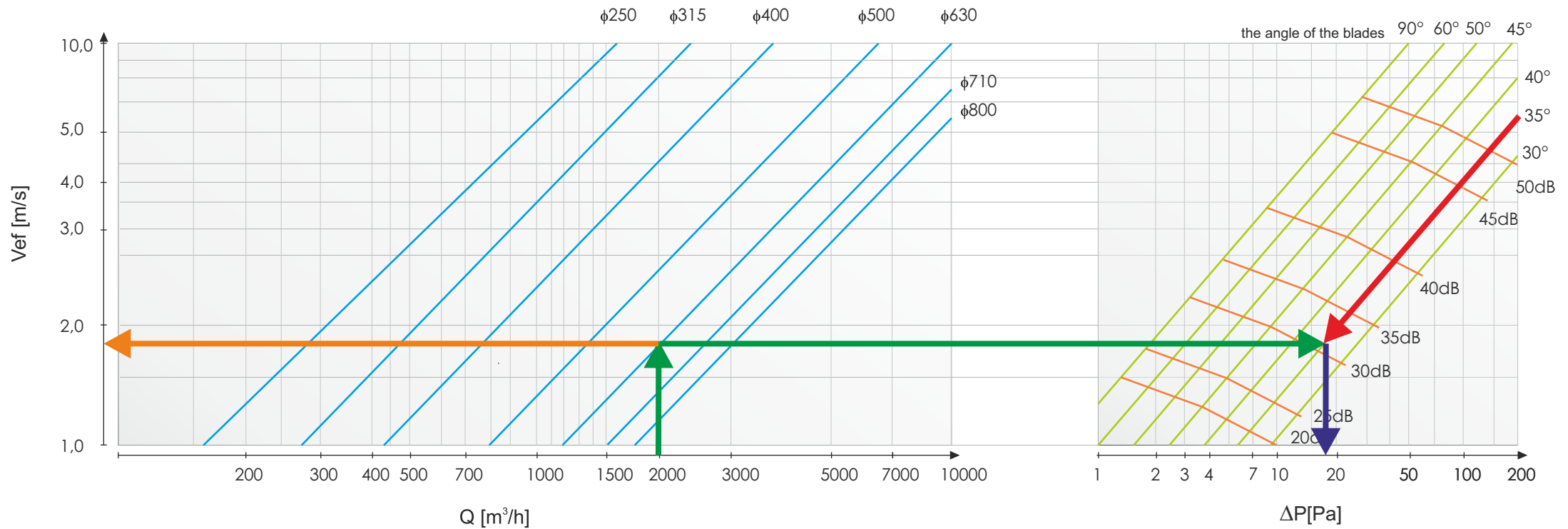

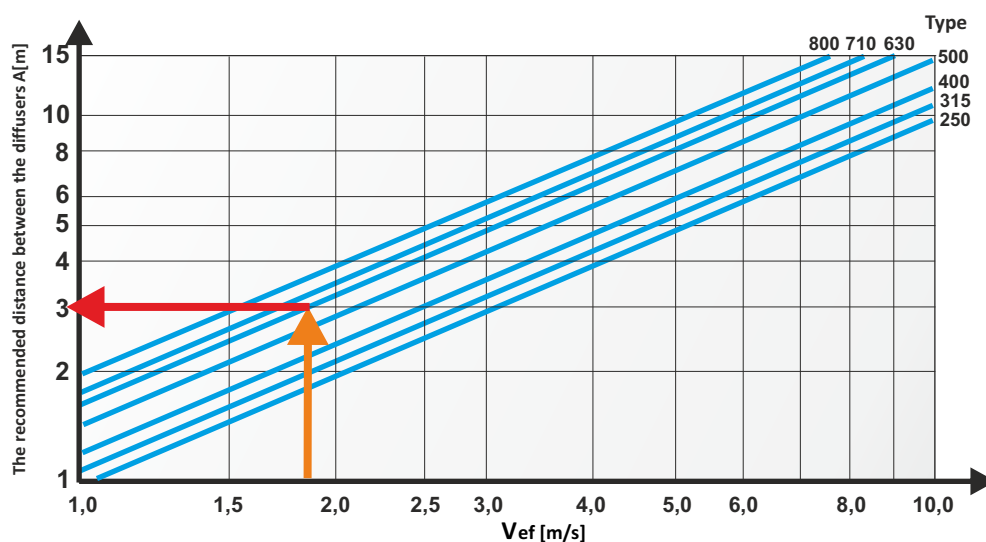

### EXAMPLE:

- speed flow of air from the diffuser  $V_{ef} = 1,8 \text{ m/s}$

### Reading from the graph:

- the recommended distance between the diffusers  $A = 3,0 \text{ m}$

## The method of placing an order

Please make orders according to the following formula:

**NWO-11 / 'R' / 'd' / 'RAL' / 'M' / 'W' + 'SR' / 'I' / 'P' / 'K' / 'H'**

- 'R' the method of adjusting the diffuser:  
**RR** - manual adjustment  
**RS-E** - Belimo actuator control (actuator on request)  
**RS-W** - wax actuator (supplied)
- 'd' the size of the diffuser: **250, 315, 355, 400, 500, 630, 710, 800, 1000**
- 'RAL' diffuser color according to RAL palette (standard RAL9016\*)
- 'M' material:  
**ST** - powder coated steel\*  
**AL** - aluminum powder coated  
**KO** - stainless steel / acid proof steel (type 1.4301 or 1.4404)
- 'W' mounting option:  
**W1** - mounting in round duct or plenum box using self-drilling screws  
**W2** - invisible assembly to the crossbar mounted in the duct / plenum box  
**W3** - mounting screws through the mounting holes in the diffuser frame
- 'SR-2' plenum box:  
**SR-G2** - plenum box with top spigot connection  
**SR-B2** - plenum box with side spigot connection
- 'I' isolation:  
**none** - plenum box without isolation\*  
**Iz** - outside isolation (thermal)  
**Iw** - inside isolation (acoustic)
- 'P' adjustment damper at spigot connection:  
**none** - no damper\*  
**P** - damper on spigot connection adjustable from the outside  
**PP** - damper on spigot connection adjustable from the inside
- 'K' diameter spigot connection in size mm
- 'H' the height of the plenum box in mm\*

\* - If you do not give the information will be used standard parameters.